

**NETAFIM**  
IRRIGATION EQUIPMENT  
& DRIP SYSTEMS

[www.netafim.com](http://www.netafim.com)

© All right reserved to netafim / Hendeimada 0901



# NETAFIM

## AQUA PRO

The smart valve with  
3 Independent  
programs + 2  
extra modes

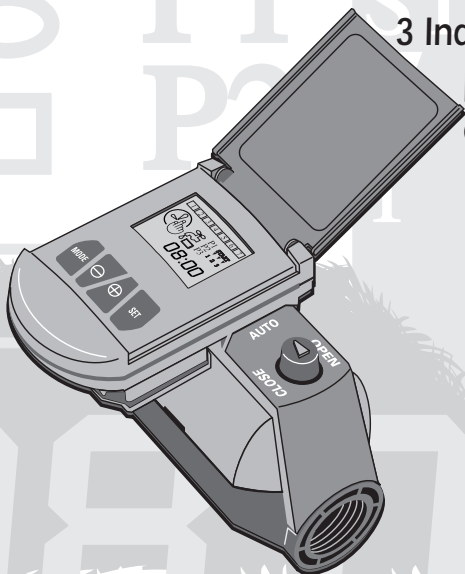

© All right reserved to netafim / Handelsmade 0901

READ & KEEP



## AQUA PRO Irrigation Controller

---

E

- Easy to use battery operated irrigation controller.
- **Two in one:** an irrigation controller and AQUANET, a state of the art electric valve combined.
- Offers 3 independent programs + 2 extra modes.

### **Programs:**

- **P1:** Once a day at the same time every day.  
(Factory preset 15 minutes at 06:00 A.M).
- **P2:** Once a day at the same time on selected Active days.
- **P3:** Up to three start times per day on selected days.

### **Extra Modes**

- **OFF:** stops all irrigation activities.
- **Manual:** to start/stop a program manually.

**Start:** press both <SET> and ⊕ keys.

**Stop:** press both <SET> and ⊖ keys.

Automatic stop: when the duration time of the active program (P) passes.

- Waterproof: I.P. 67.
- Contains a backup battery to safeguard your settings.
- Available in sizes: 3/4" and 1".

Stick your language sticker on the inside cover.

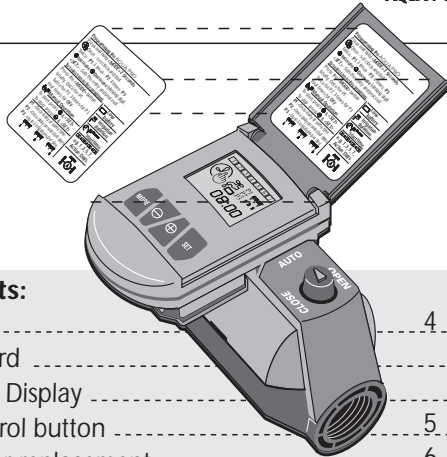

**Table of contents:**

Installation .....	4
Controller Keyboard .....	
Controller Icons & Display .....	
Electric valve control button .....	5
Battery Insertion or replacement .....	6
Installation into the watering system .....	7
Programming steps .....	8
Set P1 .....	9
Set p2 .....	10
Set P3 .....	11
Programming guide table .....	12
Controller display in operating mode .....	14
Technical information .....	
Warranty .....	15



## Installation

E

### Controller Keyboard

<MODE>: To select operating sequence and to enter programming.

<SET>: To set program values and advance to next step.

⊕: Increase program values.

⊖: Decrease program values.

### Controller Icons & Display

**Days** - represented by the digits 1-7.

Chosen day is framed.  
Current day is blinking.

**Hours** - represented in 24 hours format.

**P1, P2 or P3** - operating modes.



Set current time and day.

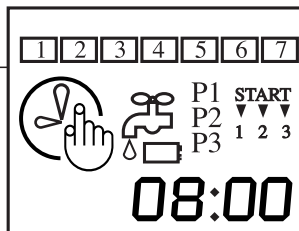

Irrigation duration.



P1 START start time.

.e.g. 1, 3, 5, 7, Active Days.

1 2 3 4 5 6 7

P3 -3 start times per day.

START START START  
1 2 3



Manual irrigation.



Low battery.

## Electric valve control buttons

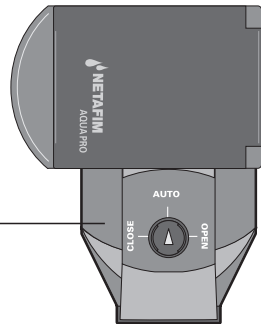
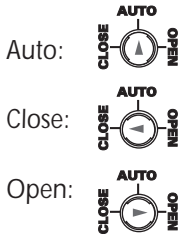

E

*Note: If the override button (marked with a red arrow) is in Close position the AQUA PRO will remain closed.*



*If the override button (marked with a red arrow) is in Open position the AQUA PRO will remain open.*

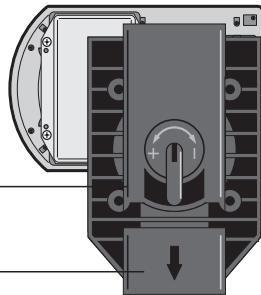

Flow Control:



Flow Direction:  
(see page 7)



## Battery Insertion or replacement

E

*Note: to operate your controller you need a high quality 9V alkaline battery (not included)*

□ The Low battery sign appears - insert or replace the battery

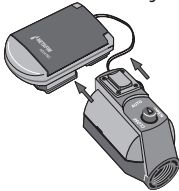

### To insert or to replace the battery:

1. Release the four screws of the battery compartment cover.
2. Gently remove the cover, seal and screws. Take care to keep the screws and seal in a safe place.
3. Insert/replace a new battery.
4. Replace the seal cover and screws
5. Tighten the screws.

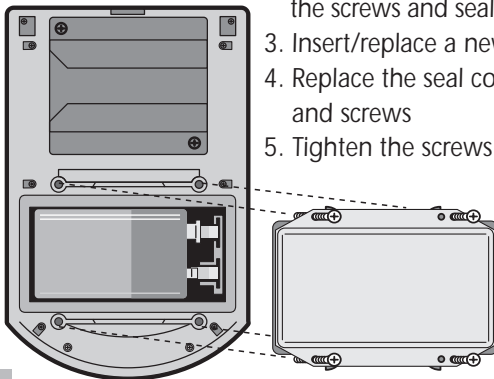

## Installation into the watering system

1. Turn off the main water supply
2. Install the AQUA PRO into the watering system making sure that the water flow is in the direction of the arrow on the base of the valve.
3. Turn on the main water supply
4. You can control the flow using the Flow Control lever on the base marked from <+> to <->.

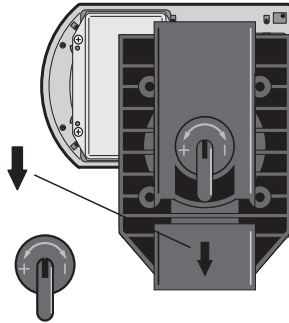

E

*When installing  
the AQUA PRO,  
hold the valve only.*

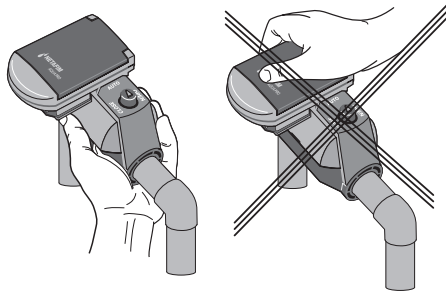



## Programming steps

E

*Note: Make sure that the override button (marked with a red arrow) is in the central position AUTO).*



### Set Clock current time and day

Press <MODE> for 2 seconds.

1. Use ⊕ or ⊖ keys to adjust (MINS.)
2. Press <SET> to continue.
3. Use ⊕ or ⊖ keys to adjust (HRS.)
4. Press <SET> to continue.
5. Use ⊕ or ⊖ keys to select day of the week.
6. Press <SET>.



**Clock setting is completed.**

### *Important!*

*If no key is pressed for more than 30 seconds during programming, the controller resumes operating mode.*

## Set P1

Once a day at the same time every day.

E

Press <MODE> twice for 2 seconds.

### Set Irrigation duration

7. Use ⊕ or ⊖ keys to adjust (MINS.)
8. Press <SET> to continue.
9. Use ⊕ or ⊖ keys to adjust (HRS.)
10. Press <SET> to continue.

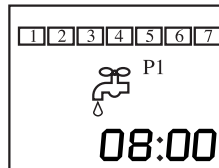

### Set irrigation starting time

11. Use ⊕ or ⊖ keys to adjust (MINS.)
12. Press <SET> to continue.
13. Use ⊕ or ⊖ keys to adjust (HRS.)
14. Press <SET> to continue.

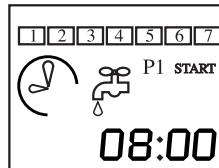

**P1 programming is completed.**



## Set P2

E

Once a day at the same time on selected Active days

*Note: Irrigation duration and start time has already been set at P1. To change irrigation duration and/or start time, go back to P1 (7-14)*

**Press <MODE> three times for 2 seconds.**

15. Press ⊕ to activate day 1.
16. Press ⊖ to deactivate day 1.
17. Press <SET> to continue to day 2
18. Press ⊕ to activate day 2.
19. Press ⊖ to deactivate day 2.
20. Set in a similar way days 3,4,5,6,7.

**P2 programming is completed.**

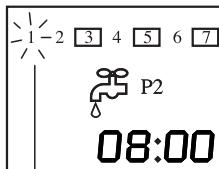

day 1 “blinks”

## Set P3

Up to three start times per day on selected Active days.

E

**Press <MODE> four times for 2 seconds.**

21. To Set duration for  $\begin{matrix} \text{START} \\ \downarrow \downarrow \downarrow \\ 1 \end{matrix}$   
(follow the instruction of P1. 7-14)
22. Set in a similar way for  $\begin{matrix} \text{START} \\ \downarrow \downarrow \downarrow \\ 2 \end{matrix}$   
and  $\begin{matrix} \text{START} \\ \downarrow \downarrow \downarrow \\ 3 \end{matrix}$
23. To Select active days  
(follow the instruction of P2. 15-20)

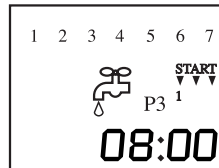

**P3 programming is completed.**

*Note: To select an active program: press the <MODE> button **briefly**: once for P1, twice for P2 three times for P3, and four times to turn the controller OFF.*

### Programming guide table (example)

E

<i>Example</i>	Day	Active day	Duration	Start time
<b>P1</b>	<b>1</b>	x	0:15	08:00
	2	x		
	3	x		
	4	x		
	5	x		
	6	x		
	7	x		

<i>Example</i>	Day	Active day	Duration	Start time
<b>P2</b>	<b>1</b>	x	0:15	08:00
	2			
	3	x		
	4			
	5	x		
	6			
	7	x		

<i>Example</i>	Day	Active day	Duration	Start time	Hour
<b>P3</b>	<b>1</b>	x	0:15	1	08:00
	2	x	0:15	2	13:00
	3		0:15	3	18:00
	4	x			
	5	x			
	6				
	7				

## Your program guide table

**P1**

Day	Active day	Duration	Start time
1	x		
2	x		
3	x		
4	x		
5	x		
6	x		
7	x		

E

**P2**

Day	Active day	Duration	Start time
1			
2			
3			
4			
5			
6			
7			

**P3**

Day	Active day	Duration	Start time	Hour
1				
2				
3				
4				
5				
6				
7				



## Controller display in operating mode

E

Real time clock

Current day (blinking)

Active mode (P1, P2, P3 or OFF).

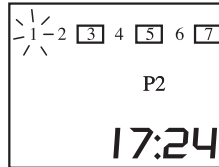

### Technical information

Flow Range: 25-6000L/H (0.1 to 26 GPM).

Minimum pressure: 0.2 BAR (3 PSI.).

Maximum pressure: 10 BAR (150 PSI).

Valve cable 0.6 M. connected to the Controller. Maximum extension from the valve to the Controller 100 M (330- feet) (cable 1.0mm Ø).

AQUA PRO controller is compatible also with Aquanet 1.5", 2". (D.C).

Operating Temperature: 0° to 50°C (32°-122°F).

Storage Temperature: -10° to 60°C (14°-140°F).

---

## Warranty

### Basic Netafim Warranty.

Netafim products are guaranteed to be free from defects in material and workmanship for a period of one (1) year from the date of delivery.

This warranty does not apply where equipment is not used and installed strictly in accordance with Netafim specifications and User Manual. Neither does it apply to failures caused by lightning strikes or damage due to freezing temperatures or mechanical causes (e.g. lawn-mowers) Netafim is not liable for indirect, incidental or consequential damage in connection with the use of equipment.

To receive warranty benefits, customers should return defective parts to the nearest Netafim distributor.

Netafim reserves the right to alter, modify or redesign its products, pricing and warranty at all times without creating any liability for the obsolescence of customer inventory of such parts or products.

This manufacturer warranty policy may apply differently in different countries.

For more information, contact your **Netafim distributor**  
Email: [postmaster@Netafim.com](mailto:postmaster@Netafim.com)